

JUNE 2024

THE Sitka Soup

HEARTY INGREDIENTS • TASTY LEFTOVERS • A DASH OF SILLINESS

Sitka
Petersburg
Wrangell
Craig
Yakutat
Kake
Angoon
Pelican
Port Alexander
Tenakee Springs

WEBSITE: SITKASOUP.COM | PHONE: (907) 747-7595 | CELL: (857) 253-8837 | EMAIL: SHOP@SITKASOUP.COM

53RD SUMMER MUSIC FESTIVAL



MAY 28 - JUNE 23

TICKETS AT
WWW.SITKAMUSICFESTIVAL.ORG & OLD HARBOR BOOKS

EVENING CONCERTS
AT HARRIGAN CENTENNIAL HALL

MEAN QUEEN
CAFÉ CONCERTS
AT MEAN QUEEN

BACH'S LUNCH
AT ODESS THEATER

MIDWEEK AT
MINER MUSIC CENTER
AT STEVENSON HALL

SEA MART
FAMILY CONCERT
PORCH AT STEVENSON HALL

ALLEN MARINE
CLASSICAL MUSIC CRUISE
DEPARTS FROM CRESCENT HARBOR

COMMUNITY CRAB FEED
AT CRESCENT HARBOR SHELTER

CLASSICAL MUSIC BRUNCH
AT STEVENSON HALL
(SOLD OUT)

VIEW FULL SCHEDULE
OF EVENTS ON PAGE 15



CALENDAR OF EVENTS

SITKA PRIDE 2024

Check out [Sitka Pride on Facebook](#) or email sitkaprider.ak@gmail.com for more information!

PRIDE CAMP

JUNE 5th – 6th
10am-2pm

Open to 5th-8th graders.
Contact katie.niedermeyer@sitkayouth.org to register.

PRIDE TRIVIA

JUNE 5th
Mean Queen Dungeon

Doors open at 5pm, trivia starts at 6pm. *Ages 21+*

DRAG SHOW

Ft. Gigi Monroe & Family

JUNE 7th and 8th | 9pm
Mean Queen Dungeon

Doors open 8pm. Follow the Mean Queen on Facebook for more info. *Age 21+*

PRIDE CRUISE

JUNE 9th | 12-3pm
Allen Marine Cruise

Follow the Mean Queen on Facebook for more info.

SKATE NIGHT

JUNE 14th | 6-8pm
Blatchley Middle School
Multi-Purpose Room

Open to all ages,
snacks provided!

LGBTQ+ HIKE

JUNE 16th | 10am
Thimbleberry Lake

Meet up for the hike
at the trailhead.

QUEER SHORTS PRIDE MOVIE NIGHT

JUNE 18th | 7pm
UAS Sitka Room 106

Watch films and help make signs for the parade!

PRIDE PARADE

JUNE 22nd | Noon
Totem Square

Join us early at 11:30 and
make signs for the parade!

VARIETY SHOW

JUNE 22nd | 7pm
Sheet'ka Kwaan Naa Kahidi

PG-13 – Open to all ages.
\$5-20, pay what you can.

QUEER COMEDY

Ft. Andy Iwancio (Seattle)

JUNE 29th | 7 and 9pm
Mean Queen Dungeon

Followed by DJ Andy Dance Party. \$20, pay what you can. *Ages 21+*



SPECIAL THANKS TO

Sitka Counseling, Mean Queen, Sitkans Against Family Violence, University of Alaska Southeast Sitka, AC Lakeside, Fortress of the Bear, & Youth Advocates of Sitka.

IN THE SPOTLIGHT

By Marcel LaPerriere

In September 2023, Sitkans Marcel and Connie LaPerriere commissioned Daniel Graham, a luthier and art professor at Georgetown College in Georgetown, Kentucky, to make a violin out of wood from Sitka, Alaska, for the Sitka Music Festival.

LaPerriere's son Zach, known for his woodworking and wood artistry, had a mixture of wood gathered over several years from around Sitka. An assortment of wood that gave Graham options and met his specifications was shipped to his Kentucky studio. As Graham started acclimatizing the wood, LaPerriere's friends and fellow supporters of the Sitka Music Festival, Dr. Don Lehmann and his wife, Penny, decided to chip in on the commission.



One goal of Graham and the LaPerrieres was not to hide the beauty of the wood under coats of dark stain. Thus, the violin was finished with a clear finish and then French polished to a high gloss to further highlight the woodgrain's splendor.

The top of the violin is made from 114-year-old Sitka spruce 2X4s salvaged during the renovation of Stevenson Hall, the home of the Sitka Music Festival. The fingerboard and tailpiece are made from ironbark that Zach LaPerriere salvaged from an old piledriver that sank in the 1980s in Leesoffskaia Bay, close to Sitka. The neck and chin rest were made from mountain ash that grew on Lincoln St. The tailpiece has a Sitka rose etched into a piece of Alaska yellow cedar.

The Sitka Violin 2024



The back is made from mountain ash salvaged from a tree that blew down on Whale Island, about three miles from downtown Sitka.

The inlay on the back of the violin is based on the stained-glass window at Saint Peter's by the Sea Episcopal Church. The church window is an icon of Sitka with a unique history. The story goes that in November 1899, a cold wintery wind blew into the church, and the wrong window arrived in Sitka. The church leaders decided to install the window, saying it was acceptable to keep that window because it harkened to the Old Testament of the Bible. By coincidence, the window resembles the rosette that is carved into the top and under the fingerboard of Sitka Music Festival's Artistic Director Zuill Bailey's Matteo Goffriller Cello, made in 1693.

The neck of the violin is mountain ash that came from a tree that was cut down near Saint Peter's by the Sea Episcopal Church.

The upper and lower bouts are yellow cedar from a dead tree that grew in Eastern Channel adjacent to the south end of Sitka. The C bouts are crabapple from a tree that grew on Peisar Island about 25 miles south of Sitka.

If the Sitka Violin weren't special enough, Graham used his printing skills on the inside of the violin. He printed a poem by his teenage daughter Olive and a photo of Paul Rosenthal, the founder of the Sitka Music Festival.



Where's
THE Sitka Soup
HEAVY INGREDIENTS • EASY LETTOUS • A DASH OF GULLIVERS

SITKA

Sea Mart Quality Foods
AC Lakeside Grocery
Market Center
Harbor Department
City Building
Highliner Coffee Co.
Sitka Ace Hardware
Harrigan Centennial Hall
Gary's Outboard
Cascade Convenience
LFS Marine
Sitka Pioneer Home

ANGOON

Angoon Trading Co.

CRAIG

AC Thompson House

KAKE

SOS Value Mart

PELICAN

Lisianski Inlet Café

PETERSBURG

Anchor Properties

PORT ALEXANDER

Delivered by F/V Eyak

TENAKEE SPRINGS

Tenakee Springs Market

WRANGELL

City Market

YAKUTAT

Mallott's General Store

Want to submit a psa,
job, announcement
or event to the Soup?

Email us at
shop@sitkasoup.com

The Sitka Soup is published monthly by Will Swagel Ink, LLC, PO Box 2844, Sitka, AK 99835, and is printed by Alaska Litho in Juneau. No part of this publication may be reproduced without permission of the publisher. We reserve the right to revise, edit, or reject any advertisement that does not meet our standards. It is the responsibility of the advertisers to check their advertisement upon the first insertion. Will Swagel Ink, LLC will not be responsible for errors or omissions that are not brought to our attention after the first insertion.

Thank you for reading the Sitka Soup!

PLEASE RECYCLE

The Soup when you are done reading it.



The Soup is printed on paper with 10% post-consumer recycled fiber

JOBS & TRAINING

City of Sitka Job Openings

There are many current job opportunities with CBS. Most of them are fulltime benefitted.

- Accounting Manager
- Asset Manager
- Dispatch and Records Clerk
- Electric T&D System Manager
- Electric Utility Director
- HCH Building Attendant
- Human Resource Director
- Jail Officer
- Journey Line Worker
- Meter Reader
- Multi-Service Officer (MSO)
- Municipal Attorney
- Planning Manager (Sign up bonus!)
- Plans Examiner
- Police Officer
- Port Security Officer
- Recreation Student Leader / Temp
- Seasonal Heavy Equipment Operator
- Temp / Customer Service Rep
- Temp Grounds Workers
- Temp Harbor Maintenance Specialist
- Temp Parks and Rec Program / Events
- Water/Wastewater Operator

Visit cityofsitka.com/jobs for full list of open positions with job descriptions, salaries, and links to apply online.

Ferry Stewards, Engineers & Seamen

AMHS is always looking for focused, hard-working individuals. Current open positions include:

- 2nd Asst Engineer(s), Hubbard
- 2nd Asst Engineer, Vacation Relief
- 3rd Asst Engineer(s), Columbia
- Able Bodied Seamen
- Business & Financial Analyst Manager
- Extra Relief Third Mate
- Oiler and Jr. Engineer
- Vessel Construction Manager

Learn more and submit an application at dot.alaska.gov/amhs/employment.shtml.

Food Service Workers & Cooks

Aramark is hiring for multiple positions! FT and PT available. Pay is \$20-\$23+/hr depending on experience. Full benefits including health/dental/vision insurance & 401K. Free meal every shift! Join our team and help support our community. Learn more at careers.aramark.com.

Harry Race Sales Associates

FT and PT positions. Join our team! Apply in our store located at 106 Lincoln Street.

Alaska Construction Training

Located on the beautiful Kenai Peninsula. Learn to how to operate heavy machinery, Project Management, and even how to bid a job! Grants are available. Free Housing! Contact us at (907) 252-0908 or akactinc@gmail.com.

Ace Hardware Positions

Several FT & PT positions available. Cashier, Sales Associate, Delivery Driver, etc. Drop an application off at our office.

Cook at Swan Lake Senior Ctr

We are seeking a part-time dependable cook to prepare and present nutritious, appealing meals for Sitka's senior citizens. Background check required. Prior professional or industrial kitchen experience required, we will train on program specifics. Must obtain State Food Worker's Card within 10 days of hire. More info at ccsak.org/jobs.



ABSOLUTE TREE CARE LLC

Topping • Trimming
Removal • Full Cleanup
Senior Discounts

(907) 738-2616 • (907) 747-7342



Marshall Albertson
Owner & Operator

- ✓ **Power Line Certified**
- ✓ **Licensed, Bonded & Insured**
- ✓ **Workman's Comp**





AKO FARMS
— DIRECT —
S I T K A A L A S K A

AWARD WINNING CANNABIS
1210 BEARDSLEE WAY
907 623 0322



Hospitality Job Opportunities

Looking for people who live in Sitka. FT & PT opportunities at Coldwater Bar & Grill, Westmark Sitka, Sitka Hotel and Baranof Lodge. Front Desk Clerks, Night Audits, Shuttle Drivers, Maintenance, Servers, Bartenders, Expos, Bussers, Host/ Hostess, Food Runners, Dishwashers, Housekeeping. Call (907) 310-9069 to set up an interview.

Juneau Summer Camp Staff

Work with kids aged 11-19 at our various culture-based summer camps. Email maddie.henson@sealaska.com with questions. Find more info and apply at sealaskaheritage.org/careers/.

Maintenance Manager

Coordinates the day-to-day maintenance and repair of the Aspen Suites Hotel building, grounds, and equipment. More info at aspenhotelsak.com/careers.

Pharmacy Tech at Harry Race

Requirements include customer service experience, attention to detail, 18+ yrs old and HS Diploma or GED. Apply today at sitkapharmacies.com.

Sheet'ká Kwáan Tribe Jobs

Current job openings include:

- Automotive Custodian
- Building Attendant
- Environmental Education Coordinator
- Environmental Lab Specialist
- Hiking / Walking Guide
- Naa Kahidi Dancer
- Natural Resources Summer Intern
- Retail Clerk
- Sitka Native Education Program Mngr
- SNEP in Schools Curriculum Writer
- Tour Guide/Driver
- Tourism Coordinator
- Traditional Foods Assistant
- Tribal Court Administrator

More info: sitkatribes.org/careers/

Sitka Counseling Jobs

Join our Team! We are currently hiring. Available Job Listings:

- Behavioral Health Clinicians
- Behavioral Health Counselor
- Clinical Associate
- Direct Support Providers

Competitive benefit package. Learn more and apply at sitkacounseling.org/careers. Contact HR at (907) 747-3636 x237 or amyz@scpsak.org with questions.

Tongass Threads Inventory Specialist / Sales Associate

Position opening June 8th for long term employment. \$17 / hour with health benefits. Must be reliable, professional, creative, flexible, self-motivated, fast paced, multitasker, responsible and trustworthy, with good "work ethic" and fun! Should have good computer skills, work well with others, lift heavy objects, and climb on a ladder as needed. Engaging with customers is required!

Transportation Security Officer

Responsible for providing security and protection of travelers across all transportation sectors in a courteous and professional manner. Apply by June 11 at jobs.tsa.gov/job/detail/785694000.

Youth Advocates of Sitka Jobs

- Clinicians
- Permanent Navigator
- Quality Assurance Technician
- Residential Youth Care Workers
- Residential Youth Case Manager
- Youth Care Worker

More info at sitkayouth.org/careers. Call (907) 747-3687 with questions.

Community Feedback Line

Reach out to us with ideas or suggestions for the summer season!

 sitkatourism@gmail.com

 (907) 747-4088



Cruise Ship & Closure Calendar

bit.ly/sitkacruisecalendar



Follow Us on Facebook

facebook.com/sitkatourism

LINCOLN STREET

CLOSURES

2024 Sitka Harbor Guide

Now online and in grocery stores!



Pick up your copy at:

Sea Mart ★ AC Lakeside ★ Market Center
Cascade Convenience ★ LFS Marine
Gary's Outboard ★ Bev's Flowers & Gifts
Harrigan Centennial Hall ★ City Building
The Harbor Department

SitkaHarborGuide.com

ANNOUNCEMENTS

Alaska Aquaculture Semester At UAS Sitka Campus

2024 Fall semester runs from Aug 26th to Dec 14th. Apply by Aug 1st. Hands-on learning and research includes courses such as: Alaska Salmon Culture, Intro to Mariculture, Fish Pathology, Aquaculture Internship & Lab, Small Vessel Operator, Outboard Motor Maintenance and Cold Water Survival. Sitka is a stronghold for Alaska aquaculture due to its pristine waters and protected coastline. For more info, visit aquaculturesemester.alaska.edu or contact Angela Bowers at (907) 747-7742 or abowers4@alaska.edu.

AMHS Summer Ferry Schedule Available for Booking Now

The summer schedule is now available for booking. To view the schedule visit dot.alaska.gov/amhs/schedules.shtml. To make reservations for travel on AMHS, call (800) 642-0066 (M-F 8am-3pm Alaska time) or visit bookamhs.alaska.gov.

Art Students Craft Xóots Piece

From UAS Sitka Art Dept & SHS
Students in Ms. Manewal's Glass & Tile class and Mr. Skultka's Advanced Formline collaborated to transform a red cedar brown bear into a work of art using glass and and tile. "Buddy" was originally carved on the SHS CNC router in 2018 during an open house. The bear will be located at the Xóots Elementary Entryway. More info at facebook.com/uas.sitka.art.department.

Aviation Class for 7+ By CBS Parks & Recreation

Youth grades 7 and up will learn about aerodynamics, airspace, navigation, and communication, from ground school instructor and private pilot Jack Davis. Activities include hands-on practice with flight simulators and field trips. The class we be at Blatchley Middle School July 8-11 from 1 - 4pm. The program is \$65, scholarships are available. For more info visit recreation.cityofsitka.com or contact Parks and Recreation by emailing recreation@cityofsitka.org or by calling (907) 747-4031.

Educators of Distinction Nominations due by July 1st

Sealaska Heritage Institute is accepting nominations for "Educators of Distinction" in an effort to highlight the role that educators play in students' academic, emotional and cultural success. Teachers, educational support staff, administrators, coaches, or "community members whose work is of such high quality as to merit recognition" may be nominated. Categories include: Distinguished Educator Award, Community-Based Learning Teaching Awards, Distinguished Leadership Award. Nominations form at bit.ly/3QeYwlo.

Gymnastic Clinics By Sitka Parks & Recreation

Taught by Trisha Bessert. Cartwheel + Handstand Clinic: June 19 & 21, 4:30 - 5:30pm. Advanced Back Handspring + Tuck: June 17, 19 & 20, 5:30 - 7pm. Must have mastery in cartwheels, handstands, roundoffs, bridge and kickovers. All clinics at Keet Gooshi Heen main gym. For more info or accomodations, contact (907) 747-4031 or recreation@cityofsitka.org. Register at recreation.cityofsitka.com.

1321 SMC Rd. (in the Sawmill Creek Plaza)

PIZZA EXPRESS

Take-Out - Delivery - Dine-In



TACOS • BURRITOS • FAJITAS • NACHOS
ENCHILADAS • PIZZA • SALADS
CHICKEN WINGS • BURGERS • SANDWICHES
APPETIZERS & MORE!



Agave Wine
Margaritas
and Cold
Mexican Beer



Call Us at (907) 966-2428
or Order Online at SitkaPizzaExpress.com

Monday - Saturday 11am - 9pm • Closed Sundays
FULL MENU available for FREE DELIVERY 'til CLOSING



- ✓ Jobs
- ✓ Announcements
- ✓ Events
- ✓ Whole Soup
- ✓ Kid's Page
- ✓ Grown Up Page
- ✓ Business Directory
- ✓ And More!

Head Start Enrollment

For 2024-2025 School Year

Head Start is a nationwide, federally funded program that promotes school readiness by enhancing the social, physical, and cognitive development of children. Head Start is provided at no cost to enrolled families and accepts children ages 3-5 years old. Communities served: Angoon, Craig, Hoonah, Juneau, Klawock, Petersburg, Saxman, Sitka, Wrangell and Yakutat. Enroll now at tinyurl.com/2024HeadStartEnroll. For more information, please contact: Tlingit & Haida Head Start at (907) 463- 7127 or headstartenrollment@tlingitandhaida.gov

Host an AFS Exchange Student

For 2024-25 School Year

Now is the time to apply to host students arriving August 2024. AFS students are 15 - 18 years old, attend Sitka High School, and are carefully selected to be good ambassadors of their countries. For more information, call Connie Kreiss on her landline at (907) 747-5387 or her cell at (907) 738-4753 or email conniekreiss@gmail.com.

Kindergarten Registration

For 2024-2025 School Year

It's time to register for kindergarten! All registration will be done online and will take around 45 minutes. Class placements for next year will begin in April so on-time registration is VERY important! Please note that your child cannot be scheduled for Baseline Assessment and class placement until your registration is submitted with all required documents to the school office. If you would like assistance or have questions, please call Xóots Elementary School at (907) 747-5825, Mon - Fri, 10am - 2pm. You can also use the Help feature on our registration website. Please visit bes.sitkaschools.org and click on the Enrollment link, then New Student Registration, then on the 24-25 Reg Form.

Library Hours Updated

For Summer 2024, Starting in May

We will be closing on Sunday and extending our evening hours two nights a week. New hours will be Mon, Wed, Fri & Sat 10am - 6pm AND Tue & Th 10am - 8pm. The Library is looking forward to offering a wider selection of times the community can access our services.

Local Seafood Shares for 2024

From Alaskans' Own

Monthly Seafood Shares are available in Sitka, Juneau, Anchorage, Fairbanks, Seattle and Bellingham. Learn more and sign up at alaskansown.com.

New Parks and Rec Website

By City and Borough of Sitka

A new website for activities and facilities. Go to recreation.cityofsitka.com and click Create New Account. Add all members of your household and get schedule changes via text. For questions or more info, contact Parks and Rec at (907) 747-4031 or recreation@cityofsitka.org.

Municipal Boards, Commissions, Committees

Volunteer Opportunities

Interested individuals may submit a board application and letter of interest to the Municipal Clerk's Office at 100 Lincoln Street or clerk@cityofsitka.org. Applications are available online at cityofsitka.com or the Municipal Clerk's Office. For further information, contact the Municipal Clerk's Office at (907) 747-1826 or clerk@cityofsitka.org.



Anchor PROPERTIES



**BUYING | SELLING | RENTING
PROPERTY MANAGEMENT**

Anchor Properties is a complete one-stop shop for all your real estate needs! Call us today, we'd love to help.

Sidney Kinney, Licensed Agent

Christine Svenson, Licensed Agent

Michael Svenson, Licensed Agent

p: 907.772.3300 | w: www.apalaska.com

HOME
Sweet
HOME

For a limited time,
buy or refinance
your home and
save \$400 on the
processing fee!
Apply online at
TongassFCU.com



TONGASS
FEDERAL CREDIT UNION

Ketchikan, Sitka, Metlakatla, Thorne Bay, Petersburg, Klawock, Wrangell, Hydaburg, Kake, Hoonah, Haines, Juneau, Yakutat

Federally Insured by NCUA. On approved credit.
NMLS#519201. Equal Housing Opportunity Lender.

ANNOUNCEMENTS

Older & Unique Car Parade

Annually on 4th of July

Organized by Jeff Budd. We are seeking cars as well as alerting neighborhoods when we will be passing through. The Older Car Parade route will start at Whale Park, leaving at 10am sharp, and head towards town, then up Lake Street and out HPR. At the HPR Rec we will turn around and head back to town, go over the bridge and back, ending at SHS. Questions? Call Jeff at (907) 747-4821.

Reading Buddies Needed

The library needs your help!

We have a lot of kids who want to be a part of our summer "Reading Buddy" program. We need more adult volunteers to meet one-on-one with a reading buddy at the library over the summer. If you're interested come to the library, fill out an application and we'll match you with your reading buddy. Questions? Call us at (907) 747-4020.

Recycling Changes & Simplification

From City and Borough of Sitka

CBS Public Works announces changes and simplifications for recycling, effective immediately. Recycle Center will now accept #5 plastic (in addition to #1 and #2 plastics). All plastics can be co-mingled in the same container. Corrugated cardboard & newspapers can now be co-mingled as well. We hope these improvements make it easier for citizens to recycle and appreciate the benefits it provides. For more info, visit cityofsitka.com or call (907) 747-1804.

Rotary Club of Sitka

Seeking New Members

Our club is seeking new members who want to make a difference – locally and internationally. The Sitka Rotary Club was chartered on January 30, 1941. We are a diverse group of community members committed to making Sitka a great place to live, work, and help each other out - while having fun along the way! Questions? Interested? Contemplating what would be involved to join? Contact Jeff Budd at jbudd3500@gmail.com.

Sitka Cirque Camps

For Kids, Teens & Adults

Summer classes and circus camps for teens, youth, and adults. Learn more and register at sitkacirque.com/classes-1 or contact us at sitkacirque@gmail.com or (907) 623-0751.

Sitka Spruce Tips 4-H Camps

By UAF & Sitka Conservation Society

Lots of Sitka camps for ages 6+ in June, July and August. Backpacking, Hiking, Woodworking & Boats, Overnight Kayak Adventure, Jr. Farmer's Market, Water & Survival Skills, Sprockets Bikepacking Overnight and more! Register for camps at 4h.zsuite.org. Scholarships available.

Sitka Trail Works Camps

For Youth Ages 8 - 18

Tidal Times: Exploring Sitka's Tidepools and Our Ocean Footprint. June 24 - 27 for youth entering grades 2 - 5. Trail Tales & Muskeg Mosaics: A Summer Camp focused on Art & Storytelling in Nature. July 8 -12. Clue Crew: Scavenger Hunts & Mysteries. Aug 5 - 8. Questions? Email youth@sitkatrailworks.org.



ISLAND MARINE, LLC

MONDAY - FRIDAY
8AM - 5PM

HONDA MARINE

SUZUKI

VOLVO PENTA

403 ALICE LOOP
(907) 747-0647
ISLANDMARINE@GCI.NET

Always wear a personal flotation device while boating and read your owner's manual.



SITKA FURNITURE & APPLIANCES

f SFA

Open Mon-Sat
10am-6pm

907-623-2003

Find all our products online at sitka.furniture

At the roundabout at
313-A Lake St, Sitka, AK 99835

Sitka Tribe Family Activities

Sharing Haa Kusteeyi (Our way of life)

Sitka Tribe of Alaska Social Services Department invites STA Tribal citizens and their families to register for Summer 2024 activities.

- June 15, 2 - 5:30pm, wildlife cruise
 - July 27, 1:30 - 5:30pm, beach excursion
 - Sept 12, 2:30 - 5:30pm, wildlife cruise
 Space is limited, registration required. Visit bit.ly/4dHwPF5 or call Jean Swanson at (907) 747-3968.

Summer Camps for Ages 6-12

By Sitka Parks & Recreation

Dates in June & July. Monday - Friday 1 - 4pm. Activities will include STEAM activities, slime time, capture the flag, cartography, painting, scavenger hunts, cooking, hiking, biking, ball sports, arts, crafting, beading, beachcombing, field trips, teambuilding activities, gym games, berry picking, music, skating and plenty more fun! Learn more about camps and session dates and register online at recreation.cityofsitka.com. For more information, please contact Parks and Recreation at recreation@cityofsitka.org or (907) 747-4031.

Summer Programs at Sitka Public Library

Adventures in Reading

- Summer Reading Program: Jun 1 - Aug 10. Read and win prizes. All ages.
 - Reading Buddy Program: Jun 1 - Aug 10. For children entering 2nd & 3rd grade.

Adventures Around the World

- Riding Wild & Free Quest: Unravel a clue every week. Starts Jun 12. Ages 6 - 10.
 - Travel Around the World Scavenger Hunt. Jul 13 - Aug 10. Best for Ages 6+.

Adventures in Food

- Free Summer Breakfast: Wednesdays at 10am. All ages. Starting June 5.
 - Adventures Cupcake Program: Jun 6. Tweens and Teens. Registration required.

Adventures in STEM

- Robotics Mini Camp: Jul 9 - 12. Grades 3 and up. Registration required.
 - PBS Odd Squad Minicamp: Aug 5 & 6. Grades 1 - 4. Registration required.

Adventures in Sports

Library Olympic Games: Week of July 23. Different activities for all ages.

Adventures in Art

- ArtTales: Cut and Paste Club: June 7, 14, & 21. Ages 7+. Registration required.

Swim Lessons

By Sitka Parks & Recreation in June & July

June 10-27 and July 8-25. All levels - Pre-school to Pre-competition, Ages 3+. Students 3-5 must be accompanied by a guardian. Instruction provided by Baranof Barracudas Swim Club. Register at sitka.recdesk.com/Community/Home.

Year-Round Scholarships

For Youth From Shee Atiká

Up to \$500 can be awarded for school and community activities throughout the year. Applications can be submitted now anytime prior to the start of an activity for youth Class A shareholders ages 5-18. More info online at sheeatika.com/our-people/scholarships-training/.

Youth Scholarships for Summer 2024 Parks & Rec

By CBS Parks & Recreation

Fee waiver scholarships now available. Apply at recreationatcityofsitka.com or cityofsitka.com. Please apply PRIOR to registering for class. For more info, contact Parks and Rec at (907) 747-4031 or recreation@cityofsitka.org.

315 Lincoln St. Suite 207 (Upstairs in the Kutees' Hit Building)

ARCTIC



CHIROPRACTIC



Dr. Jeffrey Reinhardt

Fast, excellent pain relief with pain-free chiropractic treatment!

We provide effective treatment for Spinal Disc injuries, Spinal Stenosis and Extremity injuries.

Offering massage therapy and drug-free functional medicine.

Call today for a no-obligation consultation.

(907) 747-2726

Monday - Thursday 9am - Noon & 2 - 6pm • Closed Friday



Accessible, Flexible, Attainable — and Online!

People currently in the workforce, busy parents, and students across Southeast Alaska have the opportunity to grow their careers.

Study human resources, accounting, management & more.



UNIVERSITY of ALASKA SOUTHEAST

FLEXIBLE DEGREES & CAREER PATHS | SCHOLARSHIPS & STUDENT AID

admissions@alaska.edu | uas.alaska.edu

UA is an Affirmative Action/Equal Opportunity employer and educational institution and provider and prohibits illegal discrimination against any individual: www.alaska.edu/nondiscrimination.

Thai * Chinese * Pho * Korean BBQ

(907) 966-4600

327 Seward Street

Asian Palace

Free Delivery (\$25 min) & Take Out Orders!
Must place order by 8:30pm

MON - FRI: 11AM - 9PM • SAT - SUN: NOON - 9PM

LUNCH SPECIALS

11am - 3pm (Lunch Only)
Served with steamed rice.

- 1. Phad Thai.....\$15.95**
The most popular Thai noodles! Pan fried thin rice noodles w/egg, ground peanuts, bean curd, bean sprouts, your choice of chicken, pork, beef or tofu. Add \$2 for prawns
- 2. Red Curry.....\$15.95**
Your choice of chicken, pork, beef or tofu cooked in red curry w/coconut milk, bamboo shoots & bell pepper. Add \$2 for prawns
- 3. Yellow Curry.....\$15.95**
Your choice of chicken, pork, beef or tofu cooked in yellow curry w/ coconut milk, onion, potatoes & peanuts. Add \$2 for prawns
- 4. Garlic.....\$15.95**
Stir fried chicken, pork or beef marinated w/ garlic & white pepper sauce. Add \$2 for prawns or squid
- 5. Cashew Nut Chicken.....\$15.95**
Sautéed chicken with cashew nuts, red & green pepper, onion, carrots, celery & chilli paste.
- 6. Sweet & Sour.....\$15.95**
Stir fried cucumber, tomatoes & pineapple w/ choice of chicken, pork, beef or tofu in sweet & sour sauce. Add \$2 for prawns
- 7. Mixed Veggie Deluxe.....\$15.95**
Stir fried mixed vegetables with your choice of chicken, pork, beef or tofu in oyster sauce. Add \$2 for prawns
- 8. Ginger Beef.....\$15.95**
Stir fried beef, fresh ginger & onion in brown sauce.
- 9. Kal Bi.....\$19.95**
Broiled beef short ribs in special sauce.
- 10. Bul Go Ki.....\$16.95**
Sliced beef marinated & broiled in our own sauce.

SOUPS

- 1. Egg Flower Soup.....\$7.95**
- 2. Wonton Soup.....\$8.95**
- 3. Hot & Sour Soup.....\$9.95**

APPETIZERS

- 1. Spring Rolls (2).....\$4.95**
Deep fried rolls stuffed with vegetables.
- 2. Fresh Roll (1).....\$3.95**
Rice paper-wrapped roll stuffed w/prawns, bbq pork, veggies, tiny rice noodles, served w/ our famous peanut sauce.
- 3. Crab Wonton (6).....\$9.95**
Fried crispy wontons stuffed with a rich crab & cream cheese combination, served w/ plum sauce.
- 4. Fried Chicken Wings (8).....\$13.95**
Deep fried wings served w/ sweet & sour sauce.
- 5. Egg Roll (1).....\$3.95**
Deep fried chicken-with-vegetables roll.
- 6. Coconut Prawns (5).....\$10.95**
Whole prawns tossed w/coconut flake, deep fried.
- 7. BBQ Pork Slices.....\$10.95**
- 8. Pot Stickers (10).....\$9.95**
Ground pork stuffed in wrappers, pan fried, served w/soy dipping sauce.
- 9. Combo Platter.....\$14.95**
Spring roll, crab wonton, fried chicken wings, coconut prawn, BBQ pork & fried pot stickers.

THAI CURRIES

- Served with steamed rice. Add \$2 for prawns*
- 1. Red Curry.....\$17.95**
Your choice of chicken, beef, pork, prawns or tofu cooked in a red curry w/ coconut milk, bamboo shoots & bell pepper.
 - 2. Yellow Curry.....\$17.95**
Your choice of chicken, beef, pork, prawns or tofu cooked in a yellow curry w/ coconut milk, bamboo shoots & bell pepper.
 - 3. Green Curry.....\$17.95**
Your choice of chicken, beef, pork, prawns or tofu cooked in a green curry w/ coconut milk, bamboo shoots & bell pepper.
 - 4. Mas-sa-man Curry.....\$17.95**
A rich curry from the south of Thailand with your choice of chicken, beef, pork, prawns or tofu, stewed w/ coconut milk, onion, potatoes & peanuts.

SALADS

- 1. Prawn Salad.....\$12.95**
Grilled prawns, cucumber, lettuce, tomatoes, onions.
- 2. Beef Salad.....\$11.95**
Grilled beef, cucumber, lettuce, tomatoes, onions.
- 3. Chicken or Pork Salad.....\$11.95**
Grilled chicken or pork, cucumber, lettuce, tomatoes, onions.
- 4. Chef's Salad.....\$13.95**
Shredded chicken, prawns, fresh mixed vegetables, ground cashew nuts, w/homemade green dressing.

NOODLES

- 1. Phad Thai.....\$17.95**
Oh, my gosh, these are the most popular Thai noodles! Stir fried thin rice noodles w/egg, ground peanuts, tofu, bean sprouts & your choice of chicken, beef, pork or tofu. Add \$2 for prawns
- 2. Lo Mein** *Soft steamed noodles with vegetables.*
 - Vegetable Lo Mein.....\$15.95**
 - Chicken Lo Mein.....\$15.95**
 - Pork Lo Mein.....\$15.95**
 - Beef Lo Mein.....\$16.95**
 - Shrimp Lo Mein.....\$17.95**
 - House Special Lo Mein.....\$18.95**
Mixed w/chicken, roast pork and shrimp.

PHO VIETNAMESE NOODLE SOUP

- 1. Beef Brisket.....\$16.95**
- 2. Meat Balls.....\$16.95**
- 3. Shrimp.....\$16.95**
- 4. Beef Tendon.....\$16.95**
- 5. Vegetable & Tofu.....\$16.95**
- 6. Vegetables Only (without meat).....\$16.95**
- 7. Chicken.....\$16.95**
- 8. Seafood (Shrimp, Scallop, Squid).....\$18.95**

AMERICAN FAVORITES

- 1. Fish & Chips.....\$15.95**
Breaded fish fillets, french fries, tarter/ketchup
- 2. Chicken Strips.....\$14.95**
Fried chicken strips, french fries, ranch/ketchup

*** View Full Menus Online at SitkaEats.com Please specify MENU when placing your order.**

KOREAN BBQ*Served with steamed rice and salad.*

- 1. Kal Bi.....\$26.95**
Broiled beef short ribs in special sauce.
- 2. Bul Go Ki.....\$20.95**
Sliced beef marinated & broiled in our own sauce.

RICE DISHES*Add \$2 for prawns*

- 1. Fried Rice.....\$14.95**
Rice stir fried w/ egg, mixed vegetables, your choice of chicken, beef, prawns, pork or tofu.
- 2. Yellow Curry Fried Rice.....\$14.95**
Rice stir fried in a yellow curry w/ pineapple, mixed vegetables, your choice of chicken, beef, prawns, pork or tofu.
- 3. Pineapple Fried Rice.....\$14.95**
Rice stir fried w/ egg, pineapple, mixed vegetables, your choice of chicken, beef, prawns, pork or tofu.
- 4. Chili Fried Rice.....\$15.95**
Rice stir fried w/ red & green chili, your choice of chicken, beef, prawns, pork or tofu.

PORK DISHES*Served with steamed rice.*

- 1. Sweet & Sour Pork.....\$17.95**
Fried pork w/ pineapple, sweet & sour sauce.
- 2. Pork w/ Orange Sauce.....\$17.95**
Fried pork w/ vegetables & orange sauce.
- 3. Ginger Pork.....\$17.95**
Stir fried pork w/ vegetables & sliced ginger.
- 4. Kung Pao Pork.....\$17.95**
Diced pork w/ vegetables sauteed in hot spicy sauce.
- 5. Szechuan Pork.....\$17.95**
Pork with vegetables in hot, spicy Szechuan sauce.

BEEF DISHES*Served with steamed rice.*

- 1. Beef with Oyster Sauce.....\$18.95**
Stir fried beef w/ broccoli & oyster sauce.
- 2. Kung Pao Beef.....\$18.95**
Diced veggies, beef, spicy sauce, w/ toasted peanuts.
- 3. Cashew Nut Beef.....\$18.95**
Diced vegetables, beef, brown sauce, topped w/ toasted cashew nuts.
- 4. Ginger Beef.....\$18.95**
Sliced beef, sliced ginger, onion & green peppers sautéed in hot, spicy sauce.
- 5. Mongolian Beef.....\$18.95**
Sliced beef w/onion sautéed in hot spicy sauce.
- 6. Szechuan Beef.....\$18.95**
Sliced beef w/vegetables in spicy Szechuan sauce.
- 7. Pepper Steak.....\$18.95**
Sliced beef sautéed w/green peppers.

CHICKEN DISHES*Served with steamed rice.*

- 1. Cashew Nut Chicken.....\$17.95**
Stir fried chicken w/vegetables & cashew nuts.
- 2. Orange Sauce Chicken.....\$17.95**
Stir fried chicken w/vegetables & orange sauce.
- 3. Ginger Chicken.....\$17.95**
Stir fried chicken w/vegetables & sliced ginger.
- 4. Sweet & Sour Chicken.....\$17.95**
Stir fried chicken w/ vegetables, sweet & sour sauce.
- 5. Oyster Sauce Chicken.....\$17.95**
Stir fried chicken w/ vegetables & oyster sauce.
- 6. Kung Pao Chicken.....\$17.95**
Diced chicken & vegetables sauteed in spicy sauce.
- 7. Mongolian Chicken.....\$17.95**
Sliced chicken w/ onion sautéed in hot spicy sauce.
- 8. Szechuan Chicken.....\$17.95**
Sliced chicken w/ vegetables sauteed in hot spicy Szechuan sauce.
- 9. Moo Goo Gai Pan.....\$17.95**
Chicken meat sautéed w/ vegetables.
- 10. General Tao's Chicken.....\$17.95**
Crispy sliced chicken breast w/ special hot sauce.
- 11. Sesame Chicken.....\$17.95**
Crispy sliced chicken breast w/ sesame seed sauce.

SEAFOOD DISHES*Served with steamed rice.*

- 1. Garlic Prawns.....\$19.95**
Stir fried prawns w/ garlic & vegetables.
- 2. Fried Prawns.....\$19.95**
Deep fried prawns served w/ plum sauce.
- 3. Sweet & Sour Prawns.....\$19.95**
Deep fried prawns topped w/ pineapple, tomato, onion and sweet & sour sauce.
- 4. Spicy Prawns.....\$19.95**
Stir fried prawns w/vegetables & chili paste.
- 5. Spicy Squid.....\$19.95**
Stir fried squid w/vegetables & chili paste.
- 6. Spicy Scallop.....\$19.95**
Stir fried scallop w/vegetables & chili paste.
- 7. Kung Pao Shrimp.....\$19.95**
Diced shrimp & vegetables sauteed in hot spicy sauce.
- 8. Szechuan Shrimp.....\$19.95**
Shrimp w/ vegetables & hot & spicy Szechuan sauce.
- 9. Cashew Shrimp.....\$19.95**
Stir fried shrimp w/vegetables & cashew nuts.
- 10. Happy Family.....\$19.95**
Chicken breast, pork tenderloin, scallops, shrimp, squid & top pick vegetables in house brown sauce.

DESSERTS

- 1. Cheese Cake.....\$6.95**
- 2. Mochi Ice Cream (3).....\$8.95**

VEGETABLES & TOFU*Served with steamed rice.*

- 1. Mixed Veggie Deluxe.....\$16.95**
Fresh mixed vegetables sautéed in a zesty sauce.
- 2. Broccoli with Oyster Sauce.....\$16.95**
Stir fried broccoli, carrots, onions & oyster sauce.
- 3. Cashew Nut with Tofu.....\$16.95**
Stir fried tofu w/ vegetables & cashew nuts.
- 4. Sweet & Sour Tofu.....\$16.95**
Deep fried tofu w/ sweet & sour sauce & vegetables.
- 5. Spicy Tofu.....\$16.95**
Stir fried tofu w/ chili paste & vegetables.
- 6. Ginger Tofu.....\$16.95**
Stir fried tofu w/ginger and vegetables.

KIDS MENU*Served with steamed rice or french fries.
12 years & younger only, no substitutions.*

- 1. Chicken Nuggets.....\$9.95**
- 2. Chicken Wings.....\$9.95**
- 3. Sweet & Sour Pork.....\$9.95**
- 4. Sweet & Sour Chicken.....\$9.95**

BEVERAGES

- Hot Tea or Iced Tea.....\$2.95
Soda or Juice.....\$3.95
Wine.....\$7.95/glass
Cabernet Sauvignon, Merlot, Chardonnay, White Zinfandel, Plum Wine

Kenny's Wok & Teriyaki**(907) 747-5676**
210 Katlian**MON - FRI: 11:30am - 9pm**
SAT - SUN: Noon - 9pm**FREE DELIVERY (\$20 MIN)****Little Tokyo****(907) 747-5699**
327 Seward**MON - FRI: 11am - 9pm**
SAT - SUN: Noon - 9pm**FREE DELIVERY (\$25 MIN)**

EVENTS

Sitka Pride

Celebrations and Events Throughout June
Month of June
Various Locations

Includes Pride Camp, Skate Night, LGBTQ+ Hike, Movie Night, Variety Show and Pride March. See Page 2 for full list of events with times and locations. Follow Sitka Pride on Facebook for details. Email sitkapride.ak@gmail.com with questions.

Sitka Music Festival

Numerous Events to Choose From
Various

Includes evening subscription concerts, Mean Queen Café Concerts, Bach's Lunch, Midweek at Miner Music Center, Sea Mart Family Concert, Allen Marine Classical Music Cruise, Community Crab Feed and Classical Music Brunch. See page 15 for full list of events.. Buy tickets online at SitkaMusicFestival.org or in person at Old Harbor Books.

Open Sewing Session

By Ocean Wave Quilters
Saturday, June 1, 10am - 2:45pm
at United Methodist Church

All are invited to attend. Irons, ironing boards, tables and chairs are provided. Lunch is a potluck. For more info call Linda Swanson at (907) 747-3471.

Quilters Monthly Meeting

By Ocean Wave Quilters
Saturday, June 1, 3pm
at United Methodist Church

Monthly meetings, September through June, are open to all, members or not. Those who pay \$25 dues get a monthly newsletter, class discounts and other benefits. For more info call president Jill Scheidt at (907) 738-0549.

Salmon Derby - Weekend #2

2nd Weekend of Annual Event
by Sitka Sportsman's Association
Saturday & Sunday, June 1 & 2

Follow Sitka Salmon Derby on Facebook for more details and the latest standings. This is a family event with great prizes. Best of luck to you all!

Celebration 2024 in Juneau

Four-Day Bi-Annual Event
by Sealaska Heritage Institute
Wednesday, June 5 - 8
In person in Juneau & streamed online

Our biennial festival of Tlingit, Haida, and Tsimshian cultures. Includes traditional song and dance, arts and crafts, food, and people speaking local Native languages. The event draws about 5,000 people, including more than 2,000 dancers. Thousands more watch online. More info at sealaskaheritage.org.

Marine Safety & Education

Multiple June AMSEA Classes in Sitka
June 7, 5 - 8pm & June 8, 10am - 4pm
Family Boating

June 8, 9am - 6pm
Boating Without the Boys

June 19 - 22, 8am - 5pm
Educator's Workshop

June 21, 8am - 7pm
Fishing Vessel Drill Conductor Course

June 22, 8am - 4pm
Mariner's First Aid & CPR/AED

For more info and registration visit amsea.org/upcoming-classes.

Gary's Outboard

GarysOutboard.com



Mercury and Yamaha Outboards In Stock
Available and Ready for installation

Yamaha Generators Now In Stock
Model EF 2200 IS



We Sell and Service Mercury and Yamaha Outboard Engines!



M-F 9am-5pm • 223 Smith St. • 747-9399

Father's Day YARD SALE

Hot dogs, chips and drinks for sale!
Something for everyone!



SUNDAY, JUNE 16TH
9AM - 1PM

SITKA PIONEER HOME UPPER FRONT LAWN
 (IF RAINING, SALE WILL BE IN THE BASEMENT REC. KITCHEN, RM 38)

Tribal Family Picnic

By Sitka Tribe of Alaska

Saturday, June 8, Noon - 2pm
at Halibut Point Recreation Area

Tribal youth and their families are invited. Please join us for lunch and outdoor activities, rain or shine! This is a sober and pet-free event. All youth must be accompanied by an adult. Questions? Contact Jean Swanson at (907) 747-3968 or jean.swanson@sitkatriben-sn.gov.

Adventures in Movement & Dance with Melinda McAdams

Presented by Sitka Babies and Books

Saturday, June 8, 10:30am
at Sitka Public Library

Babies, toddlers and preschoolers welcome. Pre-registration is required to reserve a new book.

Senior Kayaking

Hosted by SAIL

Monday, June 10, 1- 4pm
at Swan Lake Senior Center

The cost is \$30. For more info and to sign up contact Kari at (888) 487-1033 or krogers@sailinc.org.

Made In Sitka Markets

Two event dates in June

Tuesdays, June 11 & 25, 9am - 3pm
at Harrigan Centennial Hall

Vendor markets showcasing local Sitka food and craft artisans!

AK Native Artist Residency

Lectures, Hands-on classes and more!

June 11 - July 2
at Sheldon Jackson Museum

With Lisa Kamahamak Lynch (Inupiaq). See ad below for dates and details.

Voice & Piano Recital

Featuring Mina Brooks-Schmidt (soprano) and Susan Reed (piano)

Thursday, June 13, 7pm
at Odess Theater

Event is free. Donations accepted at the door. More info at fineartscamp.org.

R.O. Shapiro in Concert

An Americana Soul singer & songwriter

Friday, June 14, 7pm
at Odess Theater

Tickets and info at fineartscamp.org.

Shee Atika Shareholder Meeting

2024 Annual Event Held in Sitka

Saturday, June 15, 9am
at Harrigan Centennial Hall

At this time, we plan to hold the meeting in-person and via livestream so that all shareholders have an opportunity to watch—more details to come.

Pioneer Home Yard Sale

Rain or Shine, Something for Everyone

Sunday, June 16, 9am - 1pm
at Pioneer Home Upper Lawn

Something for Everyone! Hot dogs, chips and drinks for sale. See ad on page 12 for more details.

Want to submit a job, event or announcement to the Sitka Soup?
.....
EMAIL
shop@sitkasoup.com



be **adventurous**
be **sustainable**
be **healthy**
be **local**
be **ak**

high-quality local seafood with excellent service

summer hours

tuesday - saturday: 11a - 8p
closed sunday & monday



(907) 966-2326

2 lincoln street in sitka, alaska

Beak's Renee Trafton is a semi-finalist for the 2023 Best Chef Award from the James Beard Foundation!

find us online at beakrestaurant.com

The Friends of Sheldon Jackson Museum are pleased to announce

Sheldon Jackson Museum Artist-in-Residence

Lisa Kamahamak Lynch (Inupiaq)

June 11 - July 2

Beginner's Beading Class

Thursdays, June 13 & 20, 2 - 3:30 pm

Students will learn how to make either a beaded keychain or a pair of beaded earrings. Class is free but a \$10 materials fee applies. Ages 10+. Limited to 8 students.

Stop by the museum or call (907) 747-8981 to sign up.



ARTIST TALKS

In-person at the museum and on Zoom

Beadwork - A Quiet Luxury

Friday, June 14, 2 - 3 pm

History of Reindeer Herding in Alaska

Friday, June 21, 2 - 3 pm

Artifact Talk

Thursday, June 27, 2 - 3 pm

Learn more at friendsofsjm.com

104 College Drive | (907) 747-8981



Friends of Sheldon Jackson Museum

EVENTS

Community Crab Feed

A fundraiser for Sitka Music Festival
Sunday, June 16, 3 - 5pm
 at Crescent Harbor Shelter

Bring your friends and the whole family to this annual community event and feast on delicious Dungeness crab with all the fixins prepared by Our Town Catering. This is a buffet style event where you can go back for seconds or more once the initial line moves through. Get tickets at sitkamusicfestival.org or at Old Harbor Books before they sell out.

Medvejie Solstice Run

5K, 10K and Half-Marathon
Saturday, June 22, 9am
 at Herring Cove

Supporting Sitka High School Cross Country & Track Teams. Sign up now at runsignup.com - look for "Medvejie." For more info check our Facebook page @MedvejieSolsticeRun.

Sitka International Cello Seminar

Six performances by fellows and faculty
June 25 - July 14
 at Miner Music Center, Stevenson Hall
 This highly selective seminar only accepts eight participants each year. For details and dates visit sitkamusicfestival.org.

SFAC Middle School Final Concerts 2024

Students Share Their Work in Theater, Dance & Music
Thursday & Friday, June 27 & 28, 7pm
 at Sitka Performing Arts Center
 Sitka Fine Arts Camp Middle School students share their work, in theater and dance on June 27 and music (including symphonic band, orchestra, choir, and jazz band) on June 28. Events are free. Donations accepted at the door.

First 2024 Farmers Market

Fundraiser for Sitka Local Foods Network
Saturday, June 29, 10am - 1pm
 at ANB Founders Hall
 Email sitkafarmersmarket@gmail.com with questions.

Sealaska Annual Shareholder Meeting

2024 Annual Meeting Held in Sitka
Saturday, June 29, 1pm
 at Harrigan Centennial Hall
 Meeting provides a vital connection point for shareholders to meet with leadership and the board of directors, as well as to learn more about the company's business performance. We are committed to ensuring that each annual meeting is an intentional and significant experience for all shareholders, providing a platform for engagement, celebration, and dialogue. For those unable to join us in person, Sealaska will share a live webcast of the annual meeting through the MySealaska.com shareholder portal.

Jazz on the Waterfront 2024

By Sitka Fine Arts Camp
Saturday, June 29, 7pm
 at Odess Theater
 Celebrate summer at Sitka Fine Arts Camp's Jazz on the Waterfront, featuring a 20-piece big band, fine dining, dessert, and a cash bar. Black tie optional. All funds support scholarships for Sitka Fine Arts Camp. Tickets at fineartscamp.org.



**DELTA WESTERN™
 PETROLEUM**

- Home heating oil delivery service
 - Autofill service with two AK Airlines miles per gallon & \$.10/discount at the gas pump
 - Same day delivery for most call-in orders
- Marine Diesel delivery to the City Sea Wall
- Chevron & Phillips 66 brand lubricants
- Automotive Fuels

Call us at **907-747-4999** and we will set you up!



CMS
 COOPER MARINE SERVICES, LLC
 HERE TO HELP WITH ALL OF YOUR ELECTRICAL NEEDS

ELECTRICAL | ELECTRONICS | CONSULTING
 CAMERA SYSTEMS | ALARM SYSTEMS
 AUTOPILOTS | BOAT SYSTEM AUTOMATION
 REFRIGERATION CONTROL
 GAS DETECTION | EFFICIENCY & COST REDUCTION

ICOM Raymarine GARMIN SIMRAD FUJIFILM

DAN COOPER Marine Electrician (907) 738-8430

CELEBRATE ALASKA NATIVE CULTURES



Everything by Robert Hoffmann (detail)

SHELDON JACKSON MUSEUM

104 College Dr, Sitka
 907-747-8981
museums.alaska.gov



SITKA

MUSIC FESTIVAL

EVENING SUBSCRIPTION CONCERTS

HARRIGAN CENTENNIAL HALL

\$30 ADULTS, \$25 SENIOR / MILITARY / YOUTH

Fridays at 7pm: May 31 & June 7, 14, 21

Saturdays at 7pm: June 1, 8, 15

Saturday at 2:30pm: June 22

MEAN QUEEN CAFÉ CONCERTS

MEAN QUEEN

\$10 COVER

Tuesdays at 6pm (doors at 5pm): May 28 & June 11

BACH'S LUNCH

ODESS THEATER

FREE CONCERTS

Thursdays at Noon: May 30 & June 6, 13, 20

MIDWEEK AT MINER MUSIC CENTER

THE MINER MUSIC CENTER AT STEVENSON HALL

\$25 GENERAL ADMISSION

Wednesdays at 6pm (doors at 5:30pm): June 5 & 19

SPECIAL EVENTS

SEA MART FAMILY CONCERT

PORCH AT STEVENSON HALL

FREE

Sunday, June 2nd @ 3pm

~

ALLEN MARINE CLASSICAL MUSIC CRUISE

DEPARTS FROM CRESCENT HARBOR

\$110

Sunday, June 9th @ 6pm

~

COMMUNITY CRAB FEED

CRESCENT HARBOR SHELTER

\$45 GENERAL, \$30 UNDER 13

Sunday, June 16th @ 3pm

~

CLASSICAL MUSIC BRUNCH

AT STEVENSON HALL

SOLD OUT

Sunday, June 23rd @ 11am

BUY TICKETS ONLINE AT SITKAMUSICFESTIVAL.ORG OR IN PERSON AT OLD HARBOR BOOKS

GROWN UP PAGE

SITKA MUSIC FESTIVAL

The Nat Mandel Sitka Trivia Crossword - Ep. 106

Local & AK clues are **Bold**

ACROSS

- 1 Talk
- 4 Mariposa lily
- 8 Boat front
- 12 Country mentioned in "Hair"
- 13 Animal stomach
- 14 Leaf collector
- 15 Moment of comprehension
- 16 Harrigan Centennial ___ is main venue**
- 17 Land unit
- 18 ___ Falcon
- 20 Beef
- 21 Wrath
- 22 Head cover
- 23 Froth
- 26 X in Rome
- 27 Berth
- 30 Not afraid of risk
- 34 Lyric poem
- 35 East southeast
- 36 First name of originator Rosenthal**
- 37 Baseball ___
- 38 African antelope
- 40 Odyssey author
- 43 Slogged
- 47 Cain's brother
- 48 Winged
- 49 East northeast

- 50 Fossil fuel found in mine
- 51 Fewer
- 52 Disks
- 53 Lottery-like gambling game
- 54 Relieve
- 55 Query

DOWN

- 1 U.S. island territory
- 2 Nat ___ Paremski also plays "Pianissimo"**
- 3 Phoenician fertility god
- 4 Violist Martin ___ plays with Breen**
- 5 Wipe out
- 6 Very high winds
- 7 Found at Raptor Center?**
- 8 Pianist Awadagin ___**
- 9 Hurry
- 10 Gumbo veggie
- 11 "Pop ___" includes "Boogie Woogie"**
- 19 "Rag ___ Butterfly" to be played by Herskowitz**
- 20 Lucid
- 22 Possessive pronoun
- 23 ___ Schwarz
- 24 Peculiar
- 25 St. off Alice Loop is Galena ___**

1	2	3		4	5	6	7		8	9	10	11
12				13					14			
15				16					17			
18			19					20				
			21				22					
23	24	25				26				27	28	29
30				31	32				33			
34				35					36			
			37				38	39				
40	41	42				43				44	45	46
47						48				49		
50						51				52		
53						54				55		

- 26 Cafe Concert eve.**
- 27 Constrictor
- 28 Flightless bird
- 29 N.J.'s neighbor
- 31 Come close to
- 32 Teaspoon (abbr.)
- 33 Potato
- 37 Instrument of Zuill**
- 38 Mid-20th composer Phillip**
- 39 Describes Vikings?

- 40 Cut roughly
- 41 Double-reed instrument**
- 42 This "Queen" is intimate venue**
- 43 Entreaty
- 44 Factor of ten
- 45 Finis
- 46 Writing table
- 48 Exec director is ___x Serio**

THE JUNE GROWN UP PAGE IS SPONSORED BY THIS BUSINESS



228 Harbor Drive
907-747-8922
www.SitkaRealty.com

**Welcome Home To A
Happy Father's Day**

Closed Wednesday, June 19th in Observance of Juneteenth



Candi C. Barger
Owner/Broker
 907-738-1305
Candi@SitkaRealty.com



Danielle M. Cassedy
Associate Broker
 907-738-6050
Danielle@SitkaRealty.com



Shannon C. Dailey
Associate Broker
 907-738-3384
Shannon@SitkaRealty.com



Susan A. Jones
Associate Broker
 907-738-4841
Susan@SitkaRealty.com

Word Fit Find where each of the words fit into the puzzle. Use each word only once. Place the longest words first.

5 Letters

- Bruch
- Glass
- Mason
- Simon
- Vasks

6 Letters

- Brahms
- Chopin
- Dvořák
- Hersch
- Mahler
- Mozart



7 Letters

- Arensky
- Debussy

8 Letters

- Couperin
- Schubert
- Schumann

9 Letters

- Prokofiev

10 Letters

- Stravinsky

11 Letters

- Tchaikovsky

12 Letters

- Rachmaninoff

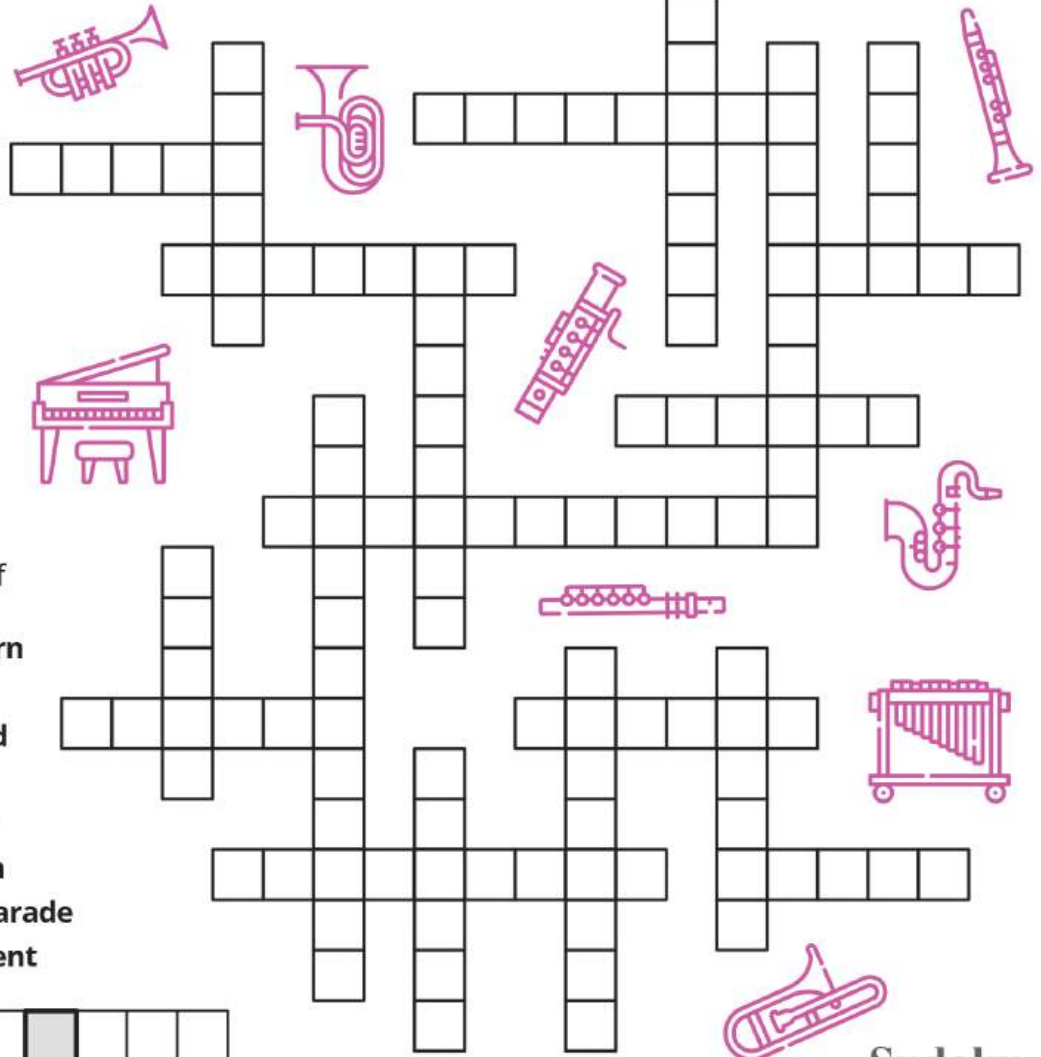

- 1) Louis Armstrong's horn
- 2) Sousaphone, e.g.
- 3) Single-reed woodwind
- 4) Upright or grand
- 5) Viola's bigger relative
- 7) Mozart's "magic" item
- 8) One of 76 in the big parade
- 9) Double-reed instrument
- 10) Stringed strummer
- 11) African xylophone
- 12) Played under the chin
- 13) Tunable large drums
- 14) Benny Goodman's "licorice stick"

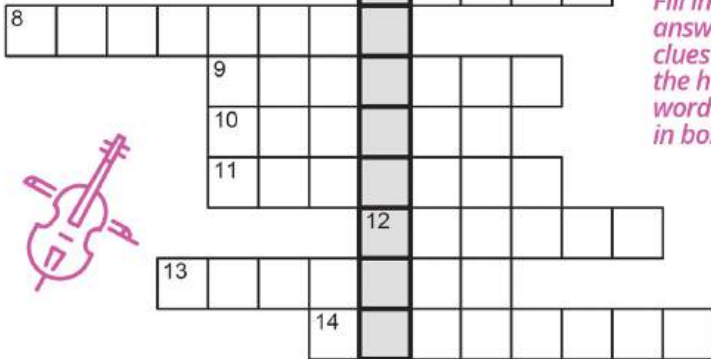

Hidden Word

Fill in the answers to the clues to find the hidden word vertically in bold.



Sudoku

Place a number in each box so that each row, column and 9-box square contains each of the numbers 1 through 9.

8				7	
4	6	3		8	
	7	4			3
					7
	9		3	6	1
5	3			9	4
	9		5		2
	2			6	1
8					9

OUT ON STANDS NOW SITKA SUMMER ARTS GUIDE



Pick up a copy today at all three grocery stores!



**WANT TO BE INCLUDED
IN THE 2024
WINTER ARTS GUIDE?**

Email shop@sitkasoup.com
or call (857) 253-8837

SitkaArts.com

Puzzle Solutions

Crossword (pg 16)

G	A	B		S	E	G	O		P	R	O	W	
U	S	A		C	R	A	W		R	A	K	E	
A	H	A		H	A	L	L		A	C	R	E	
M	A	L	T	E	S	E		S	T	E	A	K	
F	O	A	M		I	R	E		H	A	T		
A	D	V	E	N	T	U	R	E	S	O	M	E	
O	D	E		E									
H	O	M	E	R		P	L	O	D	D	E		
A	B	E	L			A	L	A	R		E	N	E
C	O	A	L			L	E	S		C	D	S	
K	E	N	O			E	A	S	E		A	S	K

Hidden Word (pg 19)

trumpet
tuba
saxophone
piano
cello
flute
trombone
bassoon
guitar
harimba
violin
timpani
clarinet

Kids Word Fit (pg 19)

quartet
chorus
melody
pitch
dynamics
violin
cello
piano

Sudoku (pg 17)

3	8	2	9	5	1	7	4	6
9	4	6	3	2	7	8	1	5
1	5	7	4	6	8	9	2	3
2	6	8	1	4	5	3	9	7
4	7	9	2	3	6	1	5	8
5	1	3	7	8	9	2	6	4
6	9	1	5	7	3	4	8	2
7	2	5	8	9	4	6	3	1
8	3	4	6	1	2	5	7	9

Grown Up Word Fit (pg 17)

brunch
debut
schubert
narrative
chopin
mozart
hermes
tchaikovsky
chopin
mozart
prokofiev
mason

Word Search (pg 19)

R O S C E L L O M N
R D G D E T E W H D
T E T R A U Q O T D
M U S I C I A N Y P
M E L O D Y I N H I
P I H H P L A D R A
I I Y N O M B R A H N
Z S T I O Q A R O
H S V I C H T O C T E
B E S C H O P M E T

June 2024 Streaming Releases & Movie Premieres

Jun 4	In the Company of Kings	NR	DVD
	Lost Soulz	NR	DVD
	The Hangman	NR	iTunes
	The Old Oak	NR	DVD
	Wicked Little Letters	R	DVD
Jun 5	Under Paris	NR	Netflix
Jun 6	Am I OK?	R	Max
Jun 7	Hit Man	R	Netflix
	Queer Planet	NR	Peacock
Jun 11	Animal Kingdom	NR	DVD
	Immaculate	NR	DVD
	King Kong x Godzilla	PG-13	DVD
	Origin	PG-13	DVD
	The Long Game	NR	DVD
Jun 12	Presumed Innocent	NR	Apple TV+
Jun 14	Ultraman: Rising	PG	Netflix
Jun 18	American Fiction	R	DVD
	Nowhere Special	NR	DVD
Jun 20	FEDERER: Twelve Final Days	R	Prime
Jun 21	Bread & Roses	NR	Apple TV+
	Trigger Warning	NR	Netflix
Jun 25	Ghosbusters: Frozen Empire	PG-13	DVD
	I Am: Celine Dion	PG-13	Prime
	The Boy and the Heron	PG-13	iTunes
	The Boys in the Boat	PG-13	DVD
	The First Slam Dunk	PG-13	DVD
Jun 28	A Family Affair	PG-13	Netflix
	Fancy Dance	R	Apple TV+
	Longing	R	iTunes

THE SOUPSTER IS ON PAGE 7

KID'S PAGE

Chamber Music

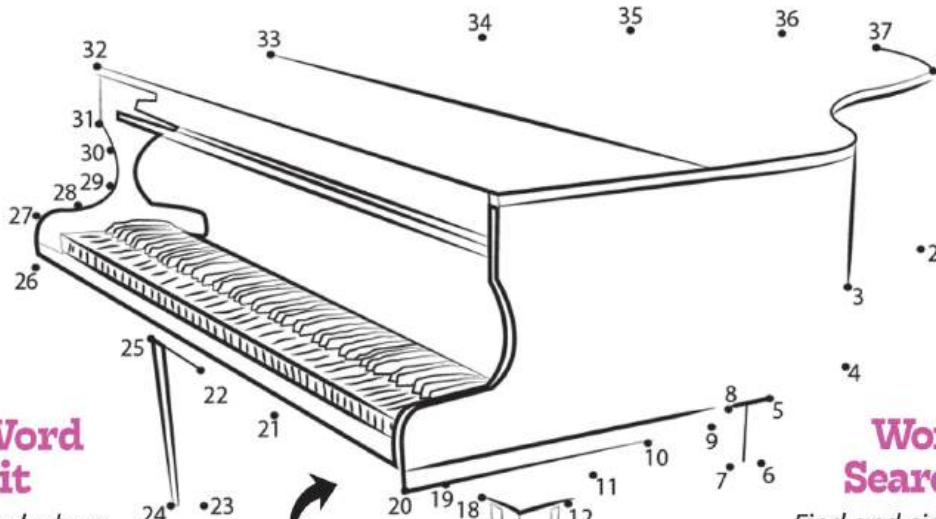

Word Fit

Find where all the words fit into the puzzle. Use each word only once.

Connect the Dots and Color the Image

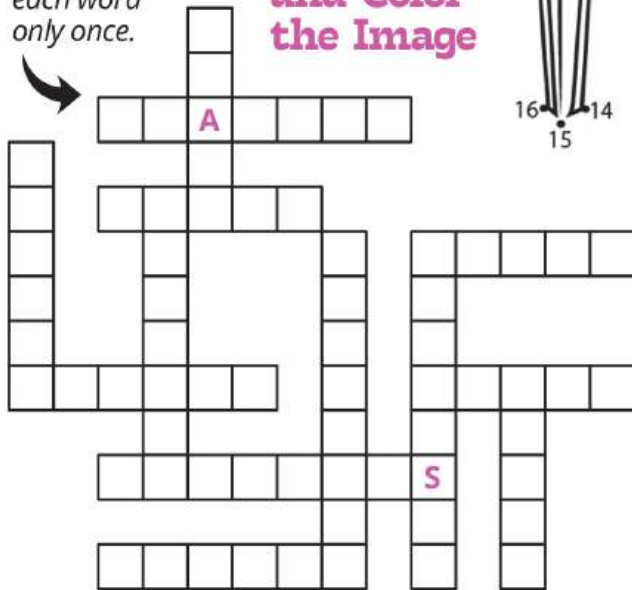

5 Letters

- cello
- chord
- piano
- pitch
- tempo

6 Letters

- melody
- rhythm
- violin

7 Letters

- harmony
- quartet

8 Letters

- composer
- dynamics
- musician

Word Search

Find and circle each of the words listed on the left.



Sea Mart Family Concert

Sunday, June 2, 3pm

Lawn in front of the Miner Music Center at Stevenson Hall

Featuring family-friendly music and discussion followed by ice cream. Come rain or shine and bring a chair! We have tents up in the event of rain. Dogs are welcome, too!









Concert is free to the public!

THE KID'S PAGE IS SPONSORED BY



- **Boiler / Furnace Sales & Maintenance**
- **Sheet Metal Fabrication**
- **Certified Refrigeration Specialists**
- **Heat Pump Sales - Most Major Brands**
- **Heat Pump Installation, Repair or Start-Up**
- **Commercial Refrigeration/Cooler Installation & Repair**



<p>Investment Property - DuPlex 2507 Sawmill Cr. Rd. \$695,000</p>  <p>±2,880 SF LIVING, ±71,986 SF LOT, POTENTIAL TO SUBDIVIDE</p>	<p>TURNKEY, CUSTOM FINISHES 109 Bahovec Court \$429,900</p>  <p>±1,098 SF FURNISHED MOBILE HOME, ±6,080 SF LOT, COMMERCIAL ZONING</p>	<p>LOT with SPACE RENTAL INCOME 3306 Halibut Pt. Rd. \$229,000</p>  <p>±13,685 SF LOT, 4 PRIVATELY OWNED MOBILE HOMES ON SITE</p>	<p>VIEWS & INCOME POTENTIAL 100 Johnson Street</p>  <p>±2,382 SF LIVING, ±10,538 SF LOT, 1 BEDROOM APARTMENT & GARAGE</p>
<p>MIDDLE ISLAND - Land for Sale Lot 2, Block 3 \$49,000</p>  <p>±1.68 ACRE LOT, ACCESS FROM COVE</p>	<p>SERENITY ISLAND L16, USS 3926 \$299,000</p>  <p>±1.75 ACRE PRIVATE ISLAND</p>	<p>CONSIDERING CONSTRUCTION? Eliason Loop Land For Sale</p>  <p>327 & 329 ELIASON LOOP ±18,528 TOTAL SF \$100,000</p>	<p>GREAT FLOOR PLAN 114 Herb Didrickson Street</p>  <p>3 BR/2.5 BATH TOWNHOUSE, ±1,782 SF LIVING AREA, ±4,000 SF LOT</p>

Davis Realty

HOMES • LOTS • ISLANDS • COMMERCIAL
Visit Us at DavisRealtySitka.com
208 D LAKE ST. SITKA, AK 99835 907- 747-1032



KERRI O'TOOLE
Owner/Broker
907-738-1907

KATHERINE GLUTH
Licensed Real Estate Agent
907-738-1536





Kachemak Inflatables

Aluminum Hulls:
8'10" • 10'2"



PVC Hulls:
7'6" • 8'10" • 9'6"



LFS MARINE SUPPLIES
475 Katlian St • (907) 747-3171 • (800) 478-3171



STORMR
Men's & Women's Jackets



Hydro Flask
Thermos & Mugs



GUY COTTEN
Suits & Coats



MUSTANG SURVIVAL
Raingear & Fleece



GIRMAN
Generators



XTRATUF
Adults, Children & Baby Booties

SUMMER HOURS: MON - FRI 8AM - 6PM • SAT 9AM - 5PM • CLOSED SUNDAY